

25A Standard SCRs

Product Summary

Symbol	Value	Unit
$I_{T(RMS)}$	25	A
$V_{DRM} V_{RRM}$	1200	V
V_{TM}	1.6	V

Features

With high ability to withstand the shock loading of large current, Provide high dv/dt rate with strong resistance to electromagnetic interference.

Application

Power charger, T-tools, massager, solid state relay, AC Motor speed regulation and so on.

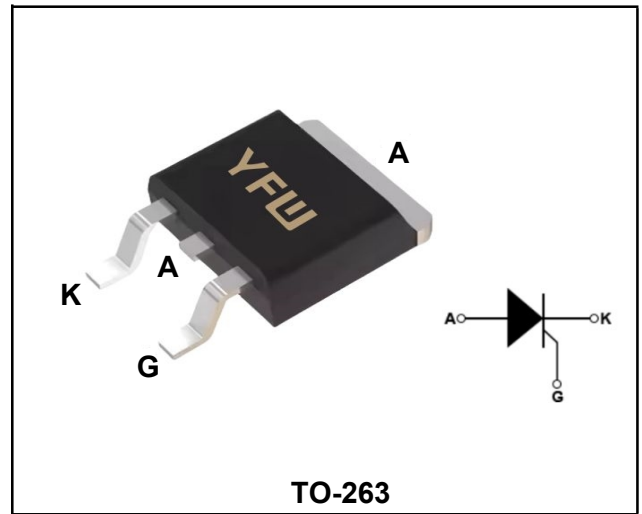

Absolute maximum ratings (Ta=25°C unless otherwise noted)

Parameter	Symbol	Value	Unit
Repetitive peak off-state voltage	V_{DRM}	1200	V
Repetitive peak reverse voltage	V_{RRM}	1200	V
Average on-state current (Tc=79°C, 180°C conduction half sine wave)	$I_{T(AV)}$	16	A
RMS on-state current(Tc=79°C, 180°C conduction half sine wave)	$I_{T(RMS)}$	25	A
One cycle Non repetitive surge current	I_{TSM}	10ms sine pulse,rated VRRM applied	250
		10mssinepulse,no voltage applied	260
I^2t value for fusing	I^2t	10msslnepulse,ratedVRRMapplied	310
		10ms sine pulse,no voltage applied	320
Critical rate of rise of on-state current (Tj=25°C)	di/dt	100	A/ μ s
Peak gate current tp=20us, Tj=125°C	I_{GM}	4	A
Average gate power dissipation Tj=125°C	$P_{G(AV)}$	1	W
Junction Temperature	T_J	-40~+125	°C
Storage Temperature	T_{STG}	-40 ~+150	°C

Electrical characteristics (T_J=25°C, unless otherwise noted)

Parameter	Symbol	Test Condition	Value			Unit
			min	typ	max	
Gate trigger current	I _{GT}	T _J =125°C	-	-	15	mA
Gate trigger voltage	V _{GT}	T _J =125°C	-	-	1.0	V
Non-triggering gate voltage	V _{GD}	V _D =V _{DRM} , T _J =125°C	0.2	-	-	V
Latching current	I _L	I _G =1.2I _{GT}	-	-	80	mA
Holding current	I _H		-	-	60	mA
Critical-rate of rise of commutation voltage	dV _D /dt	V _D =67%V _{DRM} gate open T _J =125°C	500	-	-	V/μs

STATIC CHARACTERISTICS

On-state Voltage	V _{TM}	I _{TM} =50A tp=380us	T _J =25°C	-	-	1.6	V
Repetitive Peak Off-State Current	I _{DRM}	V _D =V _{DRM}	T _J =25°C	-	-	10	μA
Repetitive Peak Reverse Current	I _{RRM}	V _R = V _{RRM}	T _J =125°C	-	-	4	mA

THERMAL RESISTANCES

Thermal resistance	R _{th (j-c)}	Junction to case		TYP.	1.0	°C/W
--------------------	-----------------------	------------------	--	------	-----	------

Ordering Information

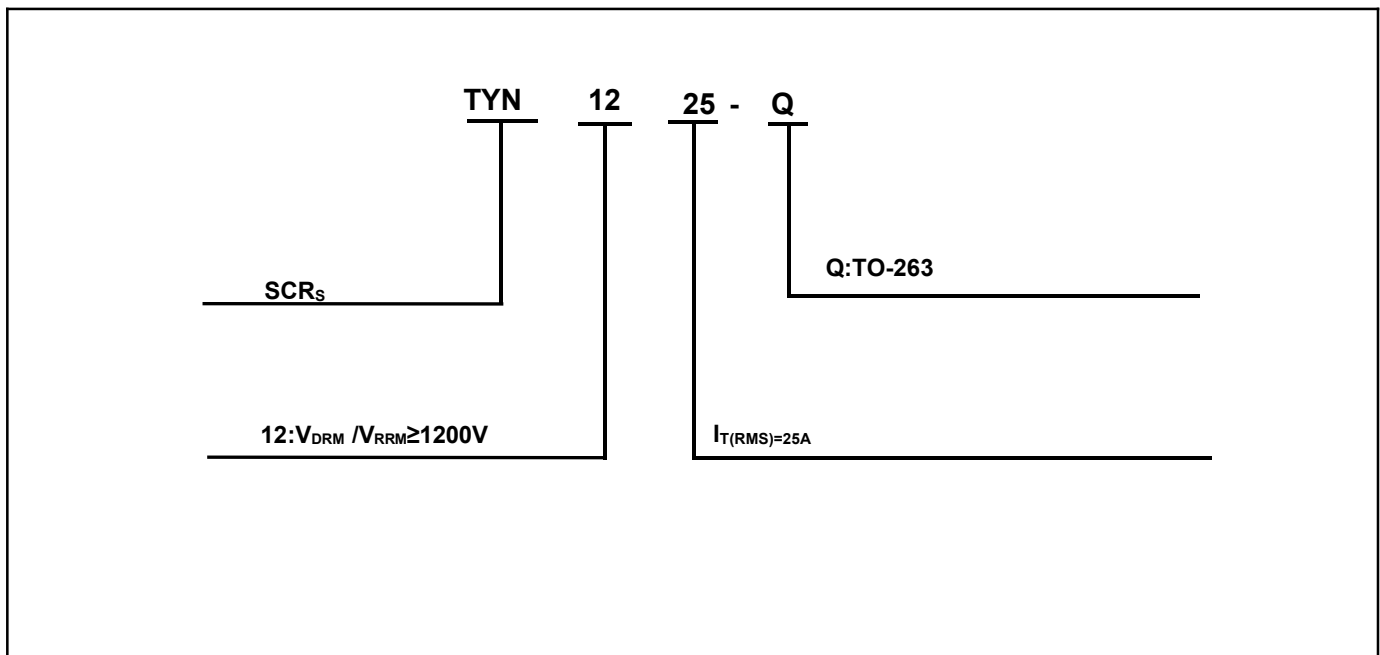

Typical Characteristics

FIG.1: Maximum average power dissipation versus average on-state current

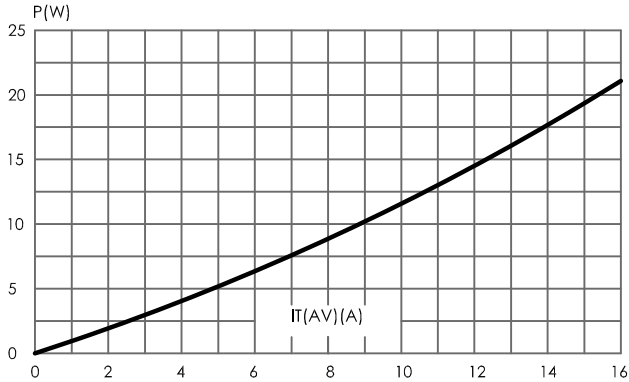

FIG.2: RMS on-state current versus case temperature.

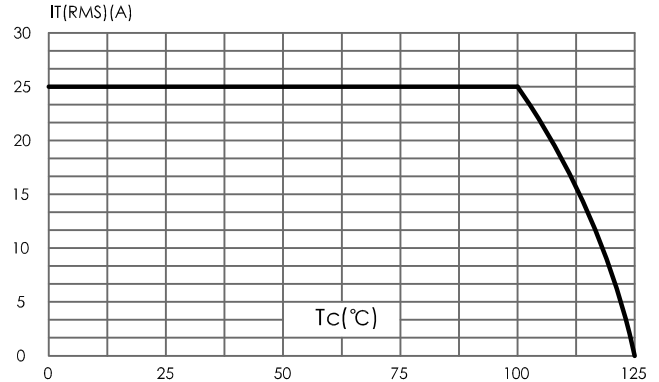

FIG.3: Relative variation of gate trigger current, holding current and latching current versus junction temperature.

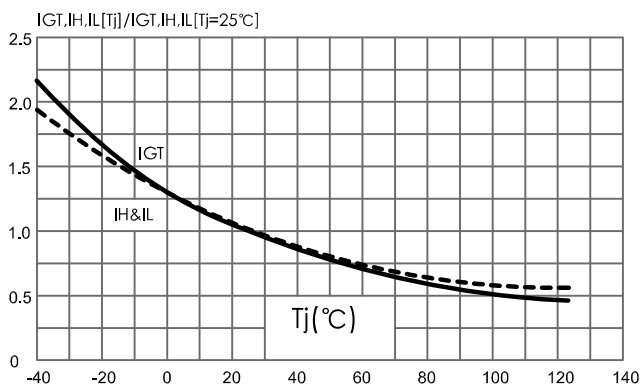

FIG.4: Surge peak on-state current versus number of cycles.

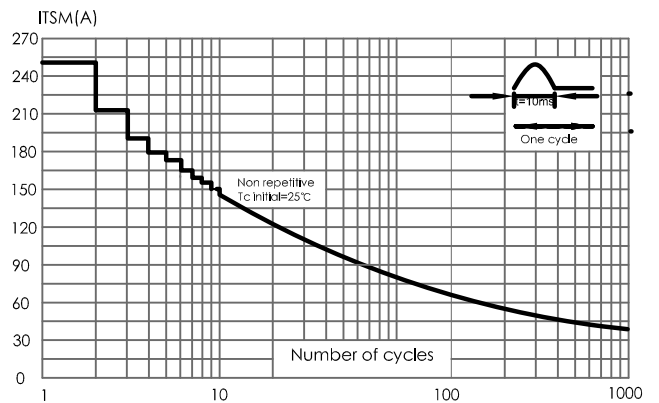

FIG.5: Non-repetitive surge peak on-state current for a sinusoidal pulse with width $t_p < 10$ ms, and corresponding value of I^2t

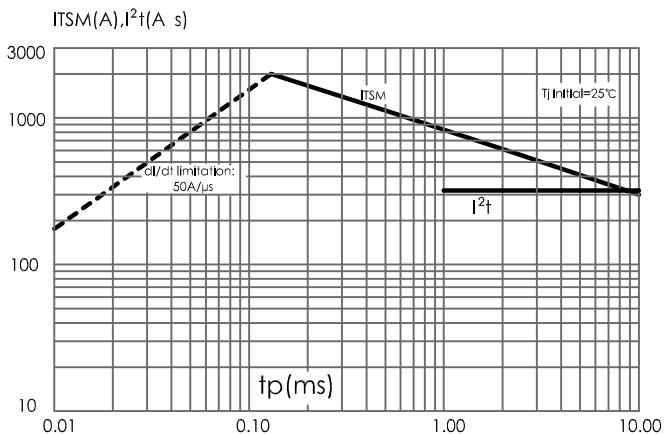
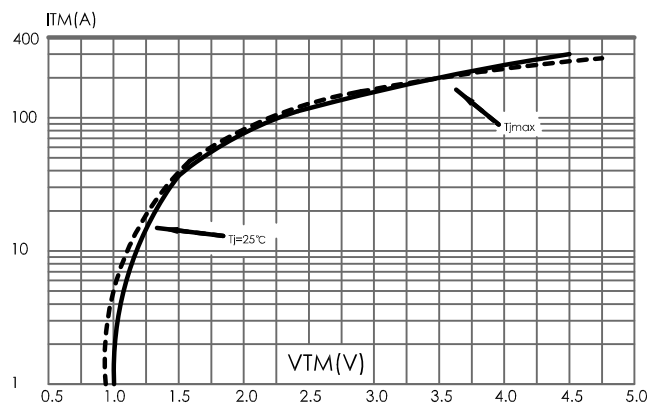
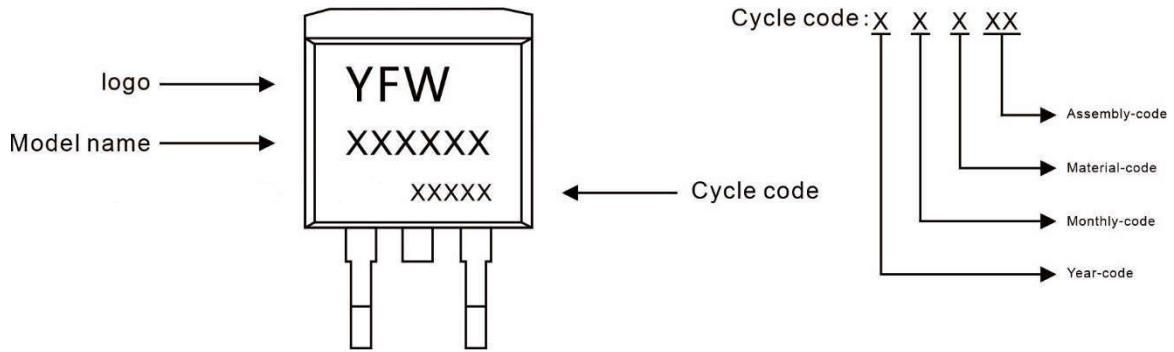

FIG.6: On-state characteristics (maximum values).



Marking Diagram



Ordering information

Model name	Package	Unit Weight	Base Quantity	Packing Quantity
TYN1225Q	TO-263	0.04oz(1.16g)	800pcs/reel	1600pcs/box 8000pcs/Carton

Package Dimensions

TO-263

Dim	Millimeter		Inches	
	Min.	Max.	Min.	Max.
A	4.30	4.70	0.169	0.185
A1	0.00	0.15	0.000	0.006
A2	4.30	4.55	0.169	0.179
B	1.10	1.50	0.043	0.059
b	0.70	0.90	0.028	0.035
b1	1.20	1.50	0.047	0.059
c	0.30	0.60	0.012	0.024
c1	1.17	1.37	0.046	0.054
D	9.90	10.35	0.390	0.407
E	8.50	9.5	0.335	0.374
e	2.44	2.64	0.096	0.104
e1	4.88	5.28	0.192	0.208
L	15.00	15.55	0.591	0.612
L1	4.30	5.30	0.169	0.208
L2	2.40	2.60	0.094	0.102
L3	1.60	1.80	0.063	0.071

Disclaimer

The information presented in this document is for reference only. GuangDong Youfeng Microelectronics Co.,Ltd. reserves the right to make changes without notice for the specification of the products displayed herein to improve reliability, function or design or otherwise. The product listed herein is designed to be used with ordinary electronic equipment or devices, and not designed to be used with equipment or devices which require high level of reliability and the malfunction of with would directly endanger human life (such as medical instruments, transportation equipment, aerospace machinery, nuclear-reactor controllers, fuel controllers and other safety devices),YFW or anyone on its behalf, assumes no responsibility or liability for any damages resulting from such improper use of sale. This publication supersedes & replaces all information previously supplied. For additional information, please visit our website <https://www.yfwdiode.com>, or consult YFW sales office for further assistance.