

SINGLE PHASE 4.0AMP GLASS PASSIVATED BRIDGE RECTIFIERS

Reverse Voltage - 100 to 1000 V

Forward Current - 4A

FEATURES

- ◆ The plastic package carries Underwriters Laboratory Flammability Classification 94V-0
- ◆ Idea for printed circuit board
- ◆ Glass passivated Junction chip
- ◆ Low reverse leakage
- ◆ High forward surge current capability
- ◆ High temperature soldering guaranteed 250°C/10 seconds at terminals

MECHANICAL DATA

- ◆ Case : Molded plastic body
- ◆ Terminals : Solder plated, solderable per MIL-STD-750, Method 2026
- ◆ Polarity : Polarity symbol marking on body
- ◆ Mounting Position : Any

Maximum Ratings and Electrical characteristics

Ratings at 25 °C ambient temperature unless otherwise specified. Single phase half-wave 60Hz, resistive or inductive load, for capacitive load current derate by 20%.

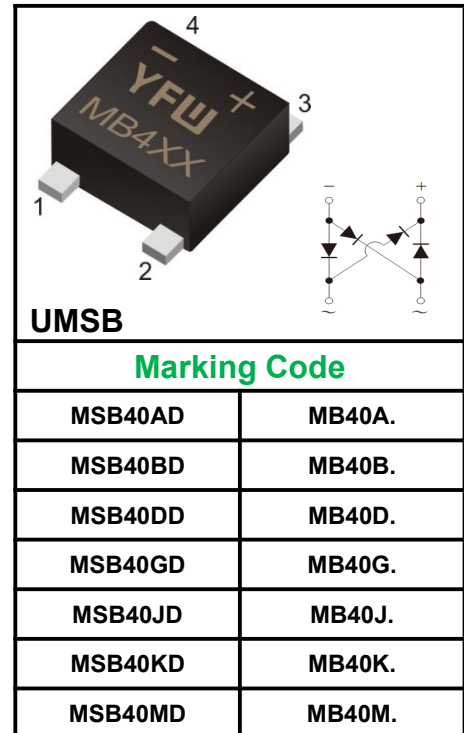

Parameter	Symbols	MSB40AD	MSB40BD	MSB40DD	MSB40GD	MSB40JD	MSB40KD	MSB40MD	Units
Maximum Repetitive Peak Reverse Voltage	V_{RRM}	50	100	200	400	600	800	1000	V
Maximum RMS voltage	V_{RMS}	35	70	140	280	420	560	700	V
Maximum DC Blocking Voltage	V_{DC}	50	100	200	400	600	800	1000	V
Maximum average forward rectified current at $T_L=100\text{ }^\circ\text{C}$	$I_{(AV)}$	4							A
Peak forward surge current, 8.3ms single half sine-wave superimposed on rated load	I_{FSM}	150							A
Rating for fusing ($t=8.3\text{ms}$, $T_a=25\text{ }^\circ\text{C}$)	I^2_t	93.3							A ² s
Forward Voltage per element at 4.0A	V_F	1.1							V
Maximum DC Reverse Current at Rated DC Blocking Voltage @ $T_A=25\text{ }^\circ\text{C}$ @ $T_A=125\text{ }^\circ\text{C}$	I_R	5 500							μA
Typical Junction Capacitance (Note1)	C_j	38.0							pF
Typical thermal resistance	R_{qJA}	55							$^\circ\text{C/W}$
Operating and Storage Temperature Range	T_j, T_{stg}	-55 ~ +150							$^\circ\text{C}$

1. Measured at 1MHz and applied reverse voltage of 4.0V D.C.

Ratings And Characteristic Curves

FIG. 1- DERATING CURVE OUTPUT RECTIFIED CURRENT

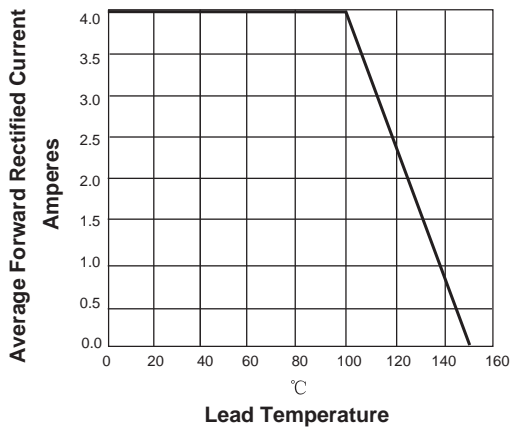

FIG. 2-MAXIMUM NON-REPETITIVE PEAK FORWARD SURGE CURRENT PERLEG

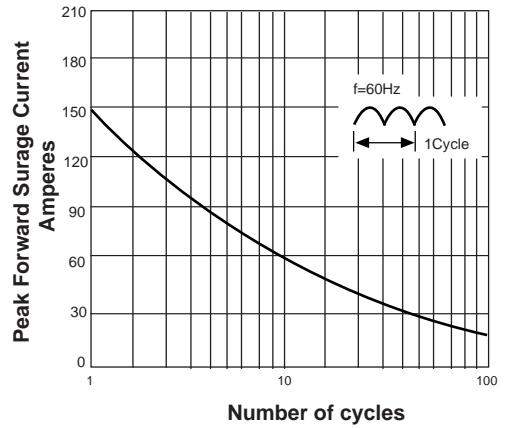

FIG. 3-TYPICAL FORWARD VOLTAGE CHARACTERISTICS

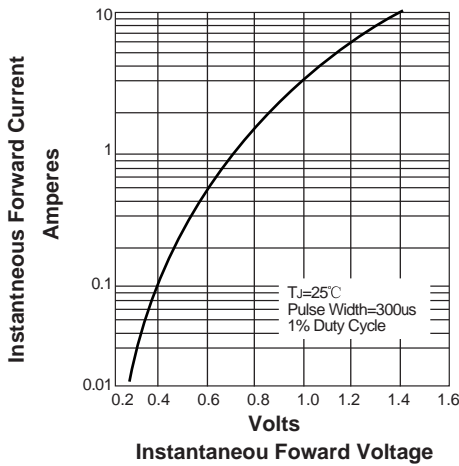
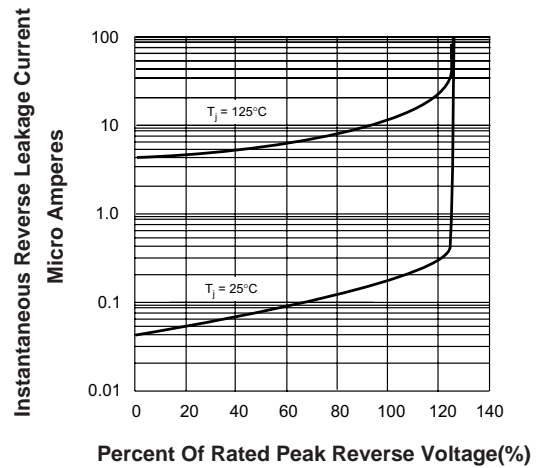
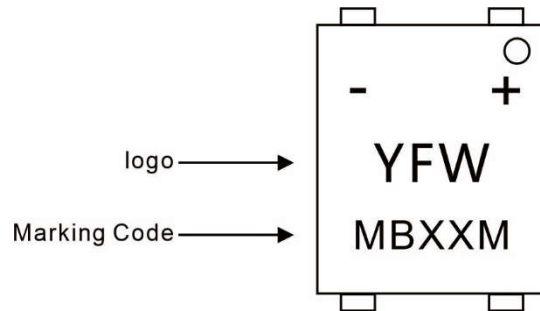

FIG. 4-TYPICAL REVERSE LEAKAGE CHARACTERISTICS



Marking Diagram



Ordering information

Package	Packing Description	Packing Quantity
UMSB	Tape/Reel, 13" reel	3000PCS/Reel 30000PCS/Carton

Package Dimensions

UMSB

Dim.	Millimeter(mm)		(mil)	
	Min.	Max.	Min.	Max.
A	1.3	1.5	51	59
C	0.17	0.29	7	12
D	6.2	7.0	244	276
E	7.1	7.6	280	299
E ₁	8.4	8.9	331	350
L	1.0	1.6	31.5	55
e	4.9	5.3	193	209
b	0.95	1.15	37	45
∠	10°			

The recommended mounting pad size

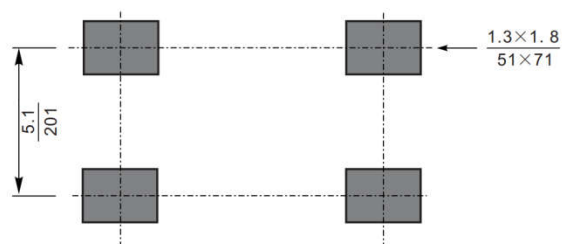

Unit: $\frac{\text{mm}}{\text{(mil)}}$

Disclaimer

The information presented in this document is for reference only. GuangDong Youfeng Microelectronics Co.,Ltd. reserves the right to make changes without notice for the specification of the products displayed herein to improve reliability, function or design or otherwise. The product listed herein is designed to be used with ordinary electronic equipment or devices, and not designed to be used with equipment or devices which require high level of reliability and the malfunction of which would directly endanger human life (such as medical instruments, transportation equipment, aerospace machinery, nuclear-reactor controllers, fuel controllers and other safety devices), YFU or anyone on its behalf, assumes no responsibility or liability for any damages resulting from such improper use of sale. This publication supersedes & replaces all information previously supplied. For additional information, please visit our website <https://www.yfwdiode.com>, or consult YFU sales office for further assistance.