

-40V P-CHANNEL ENHANCEMENT MODE MOSFET

MAIN CHARACTERISTICS

I_D	-6A
V_{DSS}	-40V
R_{DS(on)-typ(@V_{GS}=-10V)}	< 65mΩ (Type:60 mΩ)

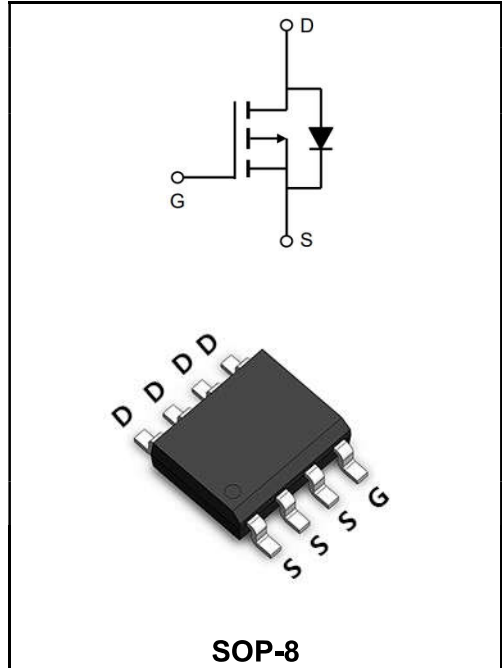

Application

- ◆ Battery protection
- ◆ Load switch
- ◆ Uninterruptible power supply

Maximum Ratings at Tc=25°C unless otherwise specified

Characteristics	Symbols	Value	Units
Drain-Source Voltage	V _{DS}	-40	V
Gate - Source Voltage	V _{GS}	±20	V
Continuous Drain Current, V _{GS} @ -10V ¹ @T _A =25°C	I _D	-6	A
Continuous Drain Current, V _{GS} @ -10V ¹ @T _A =70°C	I _D	-3	A
Pulsed Drain Current ²	I _{DM}	-16	A
Single Pulse Avalanche Energy ³	E _{AS}	21	mJ
Avalanche Current	I _{AS}	-20.5	A
Total Power Dissipation ⁴ @T _A =25°C	P _D	1.5	W
Storage Temperature Range	T _{STG}	-55 to +150	°C
Operating Junction Temperature Range	T _J	-55 to +150	°C
Thermal Resistance Junction-Ambient ¹	R _{θJA}	85	°C/W
Thermal Resistance Junction to Case ¹	R _{θJC}	50	°C/W

Maximum Ratings at Tc=25°C unless otherwise specified

Characteristics	Test Condition	Symbols	Min	Typ	Max	Units
Drain-Source Breakdown Voltage	$V_{GS}=0V, I_D=-250\mu A$	BV_{DSS}	-40	-46	-	V
BVDSS Temperature Coefficient	Reference to 25°C, $I_D=-1mA$	$\Delta BV_{DSS}/\Delta T_J$	-	-0.018	-	V/°C
Static Drain-Source On-Resistance ²	$V_{GS}=-4.5V, I_D=-3A$	$R_{DS(ON)}$	-	60	65	mΩ
	$V_{GS}=-2.5V, I_D=-2A$		-	85	100	
Gate -Threshold Voltage	$V_{DS}=V_{GS}, I_D=-250\mu A$	$V_{GS(th)}$	-1.0	-1.5	-2.5	V
$V_{GS(th)}$ Temperature Coefficient		$\Delta V_{GS(th)}$	-	2.5	-	mV/°C
Drain-Source Leakage Current	$V_{DS}=-24V, V_{GS}=0V, T_J=25^\circ C$	I_{DSS}	-	-	-1	μA
	$V_{DS}=-24V, V_{GS}=0V, T_J=55^\circ C$		-	-	-5	
Gate -Source Leakage Current	$V_{GS}=\pm 20V, V_{DS}=0V$	I_{GSS}	-	-	±100	nA
Forward Transconductance	$V_{DS}=-5V, I_D=-3A$	g_{fs}	-	5.8	-	S
Total Gate Charge(-4.5V)	$V_{DS}=-32V$ $V_{GS}=-4.5V$ $I_D=-3A$	Q_g	-	6.4	-	nC
Gate-Source Charge		Q_{gs}	-	2.1	-	
Gate-Drain Charge		Q_{gd}	-	2.5	-	
Turn-on delay time	$V_{DD}=-20V$ $V_{GS}=-4.5V$ $I_D=-3A$ $R_G=3.3\Omega$	$t_{d(on)}$	-	4.2	-	ns
Rise Time		T_r	-	23	-	
Turn-Off Delay Time		$t_{d(OFF)}$	-	26.8	-	
Fall Time		t_f	-	20.6	-	
Input Capacitance	$V_{DS}=-15V$ $V_{GS}=0V$ $f=1MHz$	C_{iss}	-	620	-	pF
Output Capacitance		C_{oss}	-	65	-	
Reverse Transfer Capacitance		C_{rss}	-	53	-	
Continuous Source Current ^{1,4}	$V_G=V_D=0V, \text{Force Current}$	I_S	-	-	-3.2	A
Pulsed Source Current ^{2,4}		I_{SM}	-	-	-16.1	A
Diode Forward Voltage ²	$V_{GS}=0V, I_S=-1A, T_J=25^\circ C$	V_{SD}	-	-	-1	V

Note :

- 1、 The data tested by surface mounted on a 1 inch FR-4 board with 2OZ copper.
- 2、 The data tested by pulsed , pulse width $\cong 300\mu s$, duty cycle $\cong 2\%$
- 3、 The power dissipation is limited by 150°C junction temperature
- 4、 The data is theoretically the same as ID and IDM , in real applications , should be limited by total power dissipation.

Ratings and Characteristic Curves

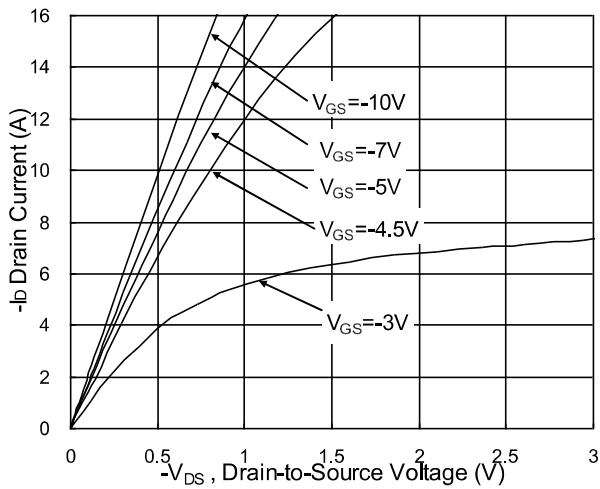

Fig.1 Typical Output Characteristics

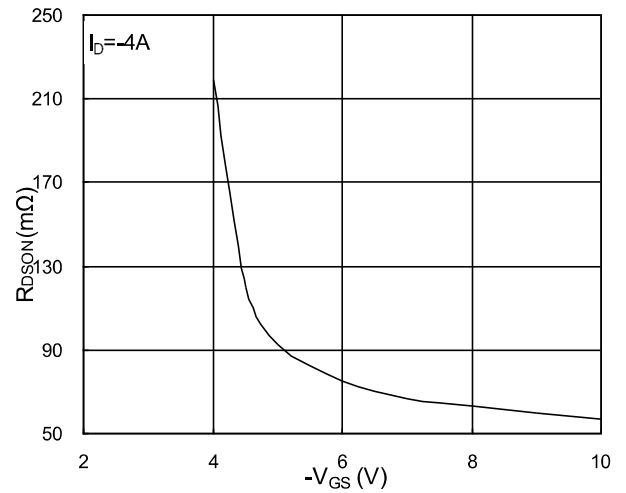

Fig.2 On-Resistance v.s Gate-Source

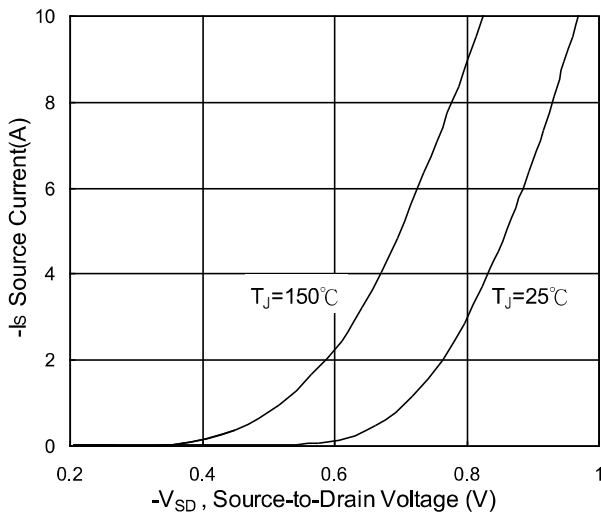

Fig.3 Forward Characteristics Of Reverse

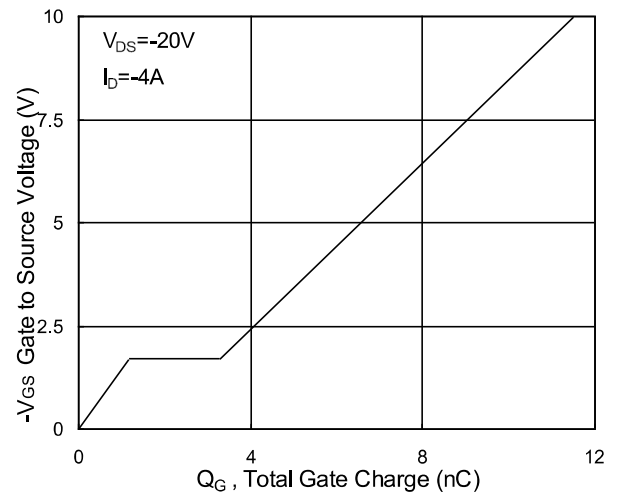

Fig.4 Gate Charge Characteristics

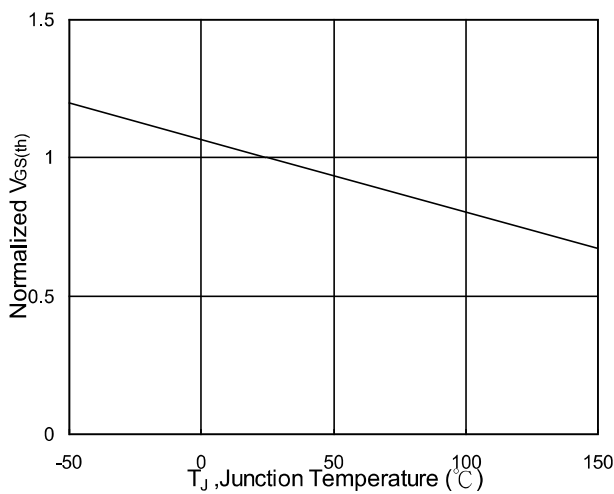

Fig.5 Normalized $V_{GS(th)}$ v.s T_J

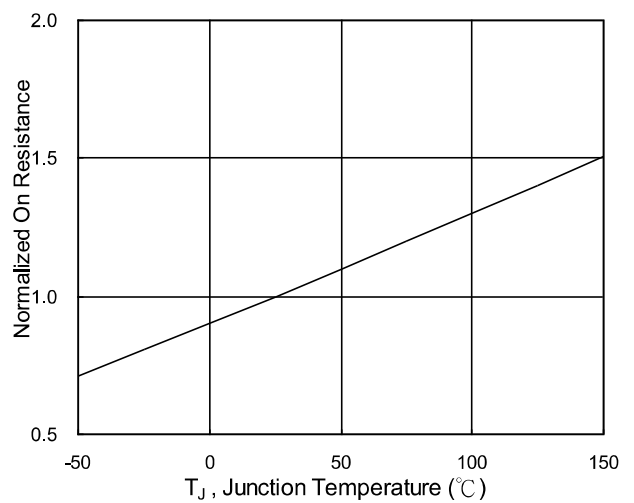

Fig.6 Normalized $R_{DS(on)}$ v.s T_J

Ratings and Characteristic Curves

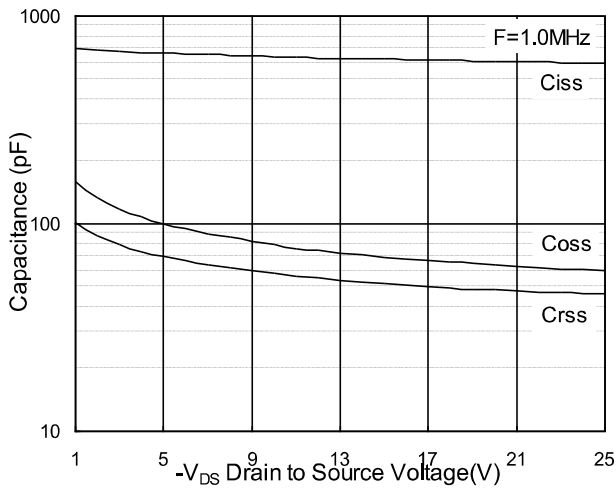

Fig.7 Capacitance

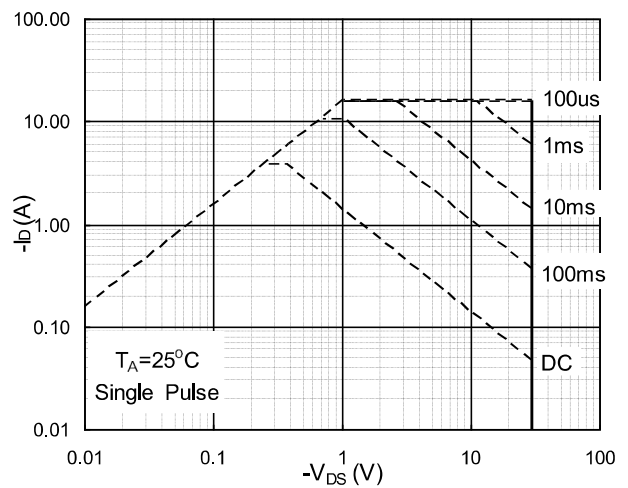

Fig.8 Safe Operating Area

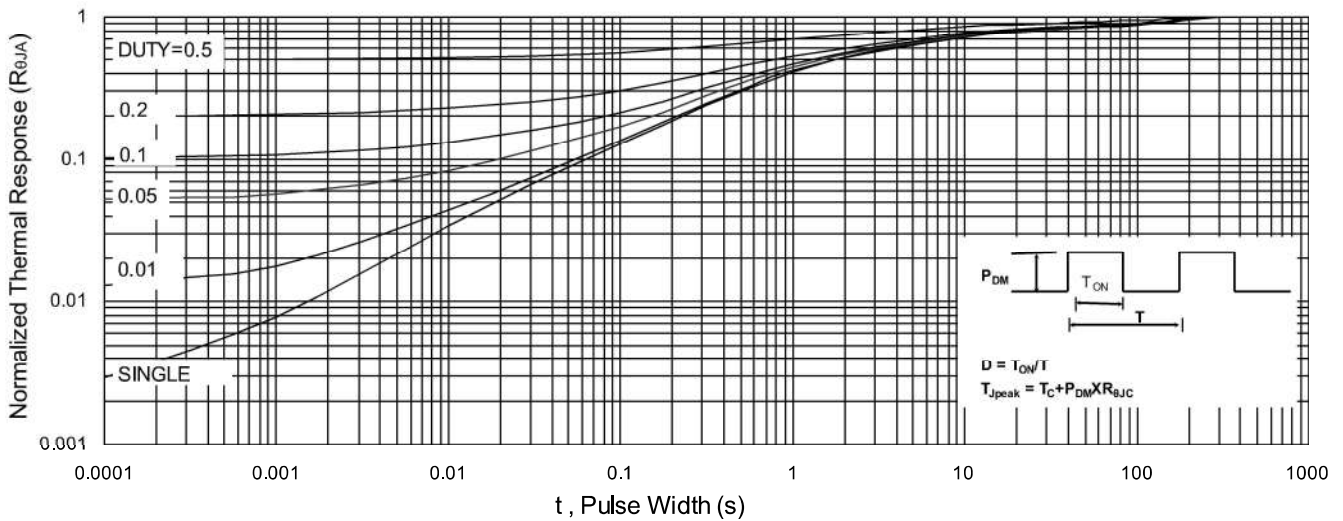

Fig.9 Normalized Maximum Transient Thermal Impedance

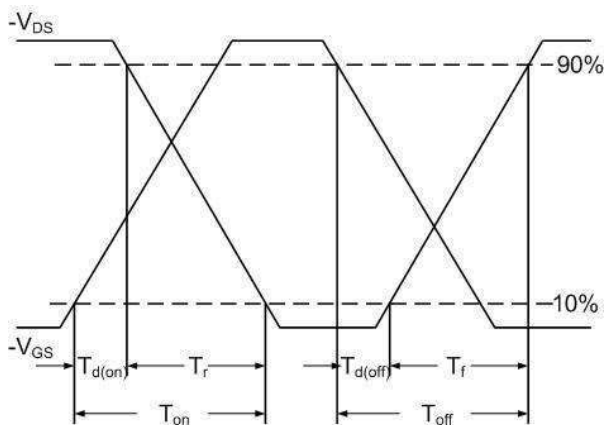

Fig.10 Switching Time Waveform

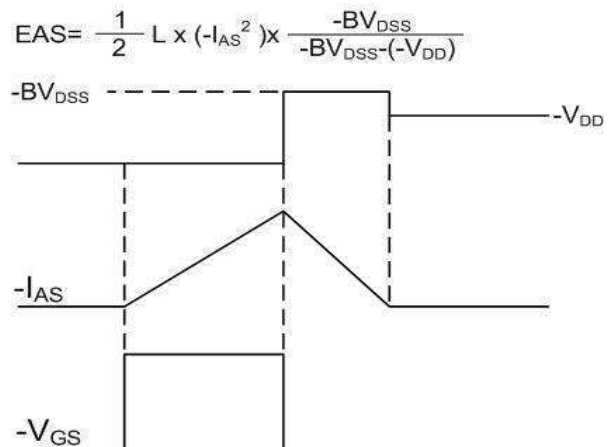
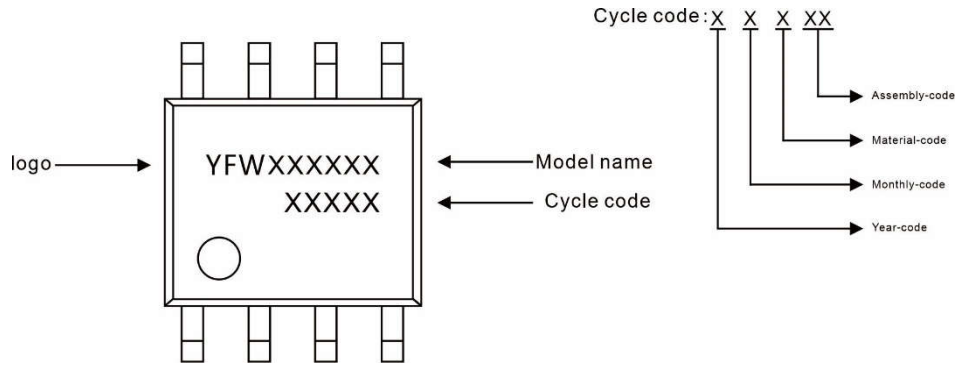

Fig.11 Unclamped Inductive Switching Waveform

Marking Diagram



Ordering information

Package	Packing Description	Packing Quantity
SOP-8	Tape/Reel, 13" reel	3000PCS/Reel 30000PCS/Carton

Package Dimensions

SOP-8

Dim	Millimeter		Inches	
	Min.	Max.	Min.	Max.
A	1.35	1.75	0.053	0.069
A1	0.10	0.25	0.004	0.010
A2	1.35	1.50	0.053	0.059
b	0.35	0.55	0.014	0.022
c	0.15	0.25	0.006	0.010
D	4.80	5.00	0.189	0.197
D1	3.10	3.50	0.122	0.138
E	5.80	6.20	0.228	0.244
E1	3.80	4.00	0.150	0.157
E2	2.20	2.60	0.087	0.102
e	1.27 (BSC)		0.050 (BSC)	
L	0.40	1.27	0.016	0.050
θ	0°	8°	0°	8°

The recommended mounting pad size

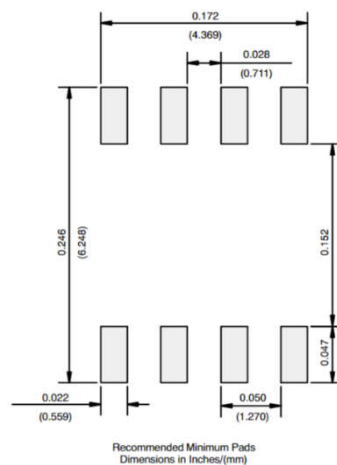

Disclaimer

The information presented in this document is for reference only. Guangdong Youfeng Microelectronics Co.,Ltd. reserves the right to make changes without notice for the specification of the products displayed herein to improve reliability, function or design or otherwise. The product listed herein is designed to be used with ordinary electronic equipment or devices, and not designed to be used with equipment or devices which require high level of reliability and the malfunction of which would directly endanger human life (such as medical instruments, transportation equipment, aerospace machinery, nuclear-reactor controllers, fuel controllers and other safety devices), YFW or anyone on its behalf, assumes no responsibility or liability for any damages resulting from such improper use of sale. This publication supersedes & replaces all information previously supplied. For additional information, please visit our website <https://www.yfwdiode.com>, or consult YFW sales office for further assistance.