

**60V N-CHANNEL ENHANCEMENT MODE MOSFET**

**MAIN CHARACTERISTICS**

<b>I<sub>D</sub></b>	160A
<b>V<sub>DSS</sub></b>	60V
<b>R<sub>DS(on)-typ(@V<sub>GS</sub>=10V)</sub></b>	<3mΩ ( <b>Typ:2.8mΩ</b> )

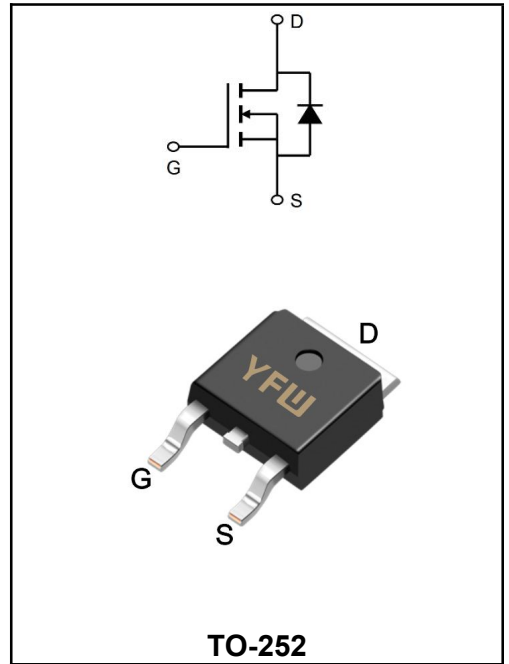

**FEATURES**

◆ Adopt advanced trench technology to provide excellent Battery protection or in other Switching application.

◆ **YFW-SGT technology**

**APPLICATIONS**

- ◆ Battery protection
- ◆ Load switch
- ◆ Uninterruptible power supply

**MECHANICAL DATA**

- ◆ Case: Molded plastic
- ◆ Mounting Position: Any
- ◆ Molded Plastic: UL Flammability Classification Rating 94V-0
- ◆ Lead free in compliance with EU RoHS 2011/65/EU directive
- ◆ Solder bath temperature 275°C maximum, 10s per JESD 22-B106

**Maximum Ratings at Tc=25°C unless otherwise specified**

Characteristics	Symbols	Value	Units
Drain-Source Voltage	<b>V<sub>DS</sub></b>	60	<b>V</b>
Gate - Source Voltage	<b>V<sub>GS</sub></b>	±20	<b>V</b>
Continuous drain current	<b>I<sub>D</sub></b>	160	<b>A</b>
Pulsed drain current(Note1)	<b>I<sub>DM</sub></b>	240	<b>A</b>
Power dissipation	<b>P<sub>D</sub></b>	210	<b>W</b>
Single pulsed avalanche energy(Note1)	<b>E<sub>AS</sub></b>	650	<b>mJ</b>
Operation and storage temperature	<b>T<sub>STG</sub> ,T<sub>J</sub></b>	-55 to +150	<b>°C</b>
Thermal Resistance Junction-Case	<b>R<sub>θJC</sub></b>	0.59	<b>°C/W</b>
Thermal Resistance, Junction-to-Ambient	<b>R<sub>θJA</sub></b>	50	<b>°C/W</b>

Note1:Pulse test: 300 μs pulse width, 2 % duty cycle

**Maximum Ratings at Tc=25°C unless otherwise specified**

Characteristics	Test Condition	Symbols	Min	Typ	Max	Units
Drain-Source Breakdown Voltage	$V_{GS}=0V, I_D=250\mu A$	<b><math>BV_{DSS}</math></b>	60	-	-	<b>V</b>
Zero Gate Voltage Drain Current	$V_{DS}=60V, V_{GS}=0V$	<b><math>I_{DSS}</math></b>	-	-	1.0	<b><math>\mu A</math></b>
Gate to Body Leakage Current	$V_{GS}=\pm 20V, V_{DS}=0V$	<b><math>I_{GSS}</math></b>	-	-	$\pm 100$	<b>nA</b>
Gate Threshold Voltage	$V_{DS}=V_{GS}, I_D=250\mu A$	<b><math>V_{GS(th)}</math></b>	2.0	-	4.0	<b>V</b>
Drain-Source On-State Resistance	$V_{GS}=10V, I_D=20A$	<b><math>R_{DS(ON)}</math></b>	-	2.8	3	<b>m<math>\Omega</math></b>
Transconductance	$V_{DS}=5V, I_D=20A$	<b><math>g_{fs}</math></b>	-	130	-	<b>S</b>
Input Capacitance	$V_{DS}=25V$ $V_{GS}=0V$ $f=1.0MHz$	<b><math>C_{iss}</math></b>	-	4200	-	<b><math>\mu F</math></b>
Output Capacitance		<b><math>C_{oss}</math></b>	-	1080	-	
Reverse Transfer Capacitance		<b><math>C_{rss}</math></b>	-	41	-	
Total Gate Charge	$V_{DS}=30V$ $I_D=20A$ $V_{GS}=10V$	<b><math>Q_g</math></b>	-	42	-	<b>nC</b>
Gate-Source Charge		<b><math>Q_{gs}</math></b>	-	10	-	
Gate-Drain("Miller") Charge		<b><math>Q_{gd}</math></b>	-	12	-	
Turn-on delay time	$V_{DS}=30V$ $I_D=100A$ $R_G=3\Omega$ $V_{GS}=10V$	<b><math>t_{d(on)}</math></b>	-	13.5	-	<b>ns</b>
Turn-on Rise Time		<b><math>T_r</math></b>	-	95.5	-	
Turn-Off Delay Time		<b><math>t_{d(OFF)}</math></b>	-	40	-	
Turn-Off Fall Time		<b><math>t_f</math></b>	-	110	-	
Maximun Body-Diode Continuous Current		<b><math>I_S</math></b>	-	-	160	<b>A</b>
Drain to Source Diode Forward Voltage	$V_{GS}=0V, I_S=30A$	<b><math>V_{SD}</math></b>	-	-	1.2	<b>V</b>
Body Diode Reverse Recovery Time(Note2)	$T_J=25^\circ C, I_F=60A$ $di/dt=100A/\mu s$	<b><math>t_{rr}</math></b>	-	35	-	<b>ns</b>
Body Diode Reverse Recovery Charge(Note2)		<b><math>Q_{rr}</math></b>	-	30	-	<b>nC</b>

**Note2:Pulse test: 300  $\mu s$  pulse width, 2 % duty cycle**

Ratings and Characteristic Curves

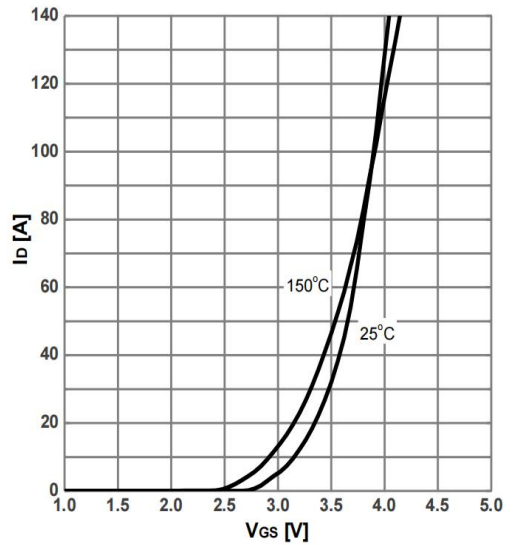
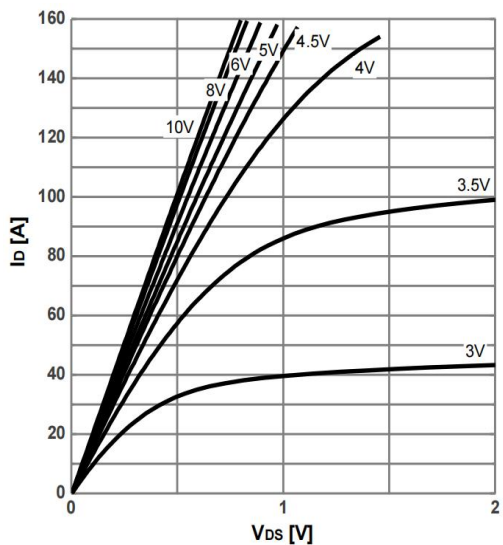
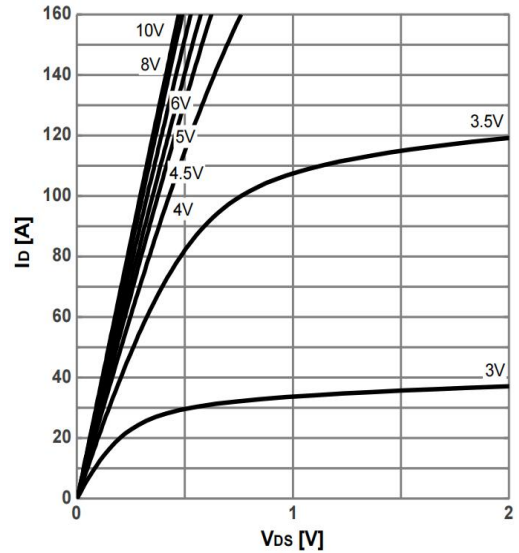
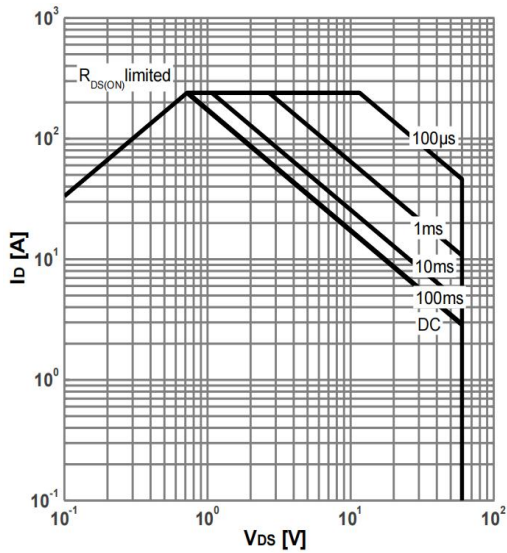
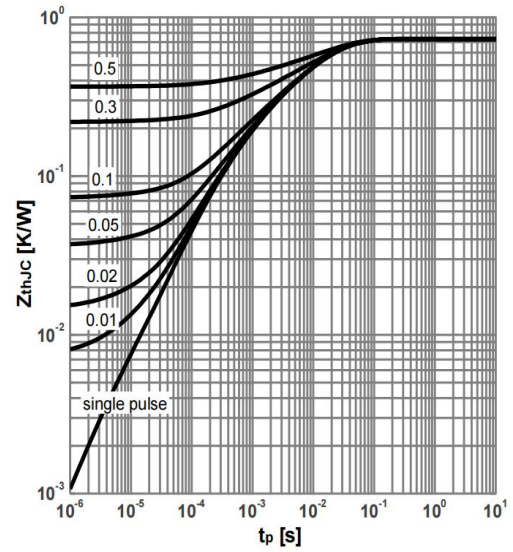
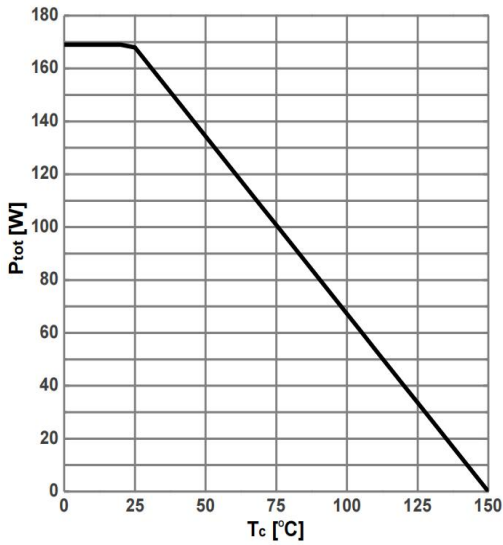

Ratings and Characteristic Curves

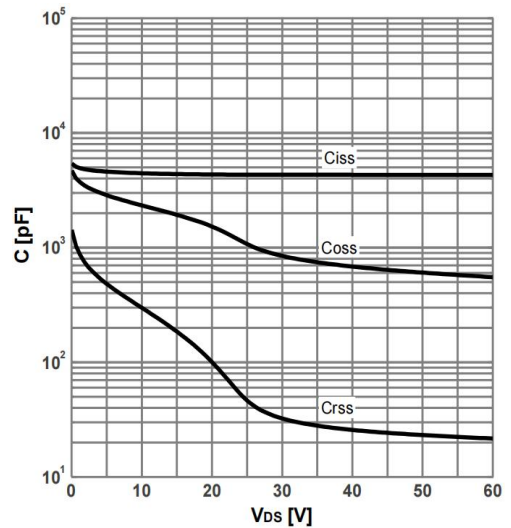
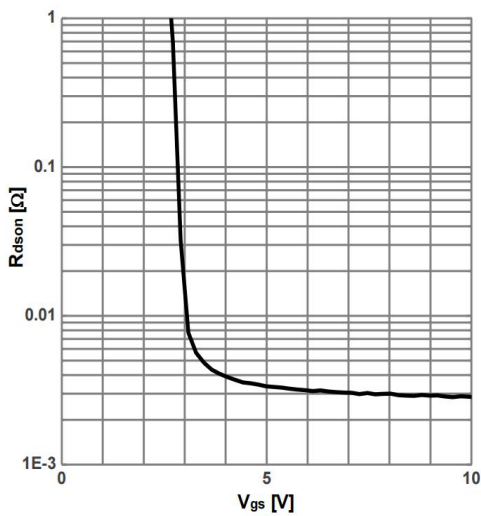
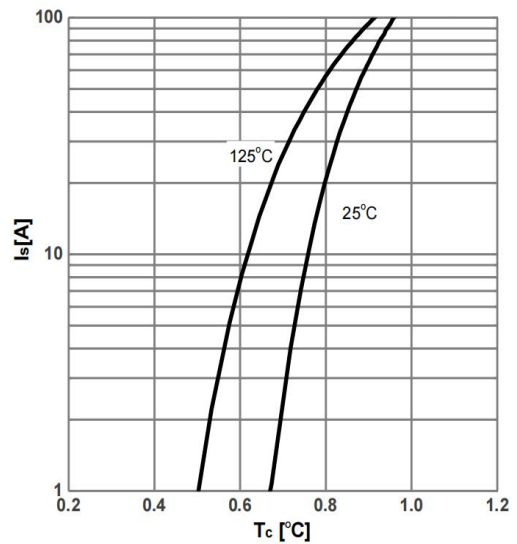
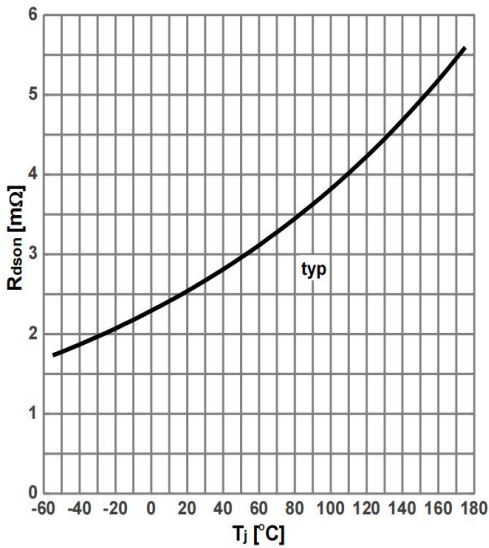
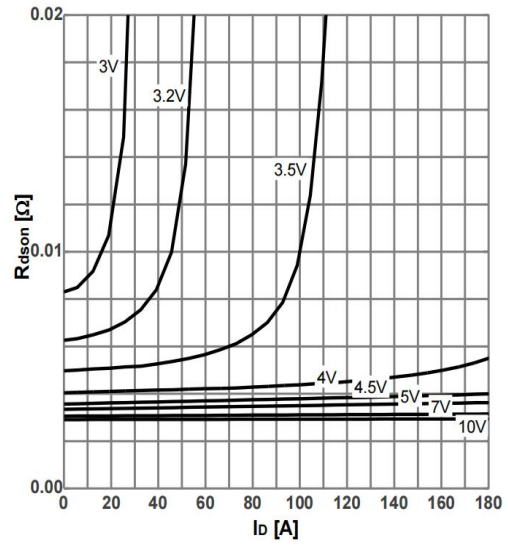
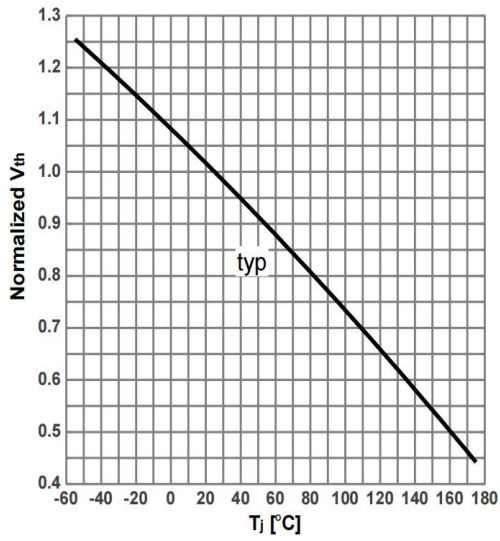

**Marking Diagram**

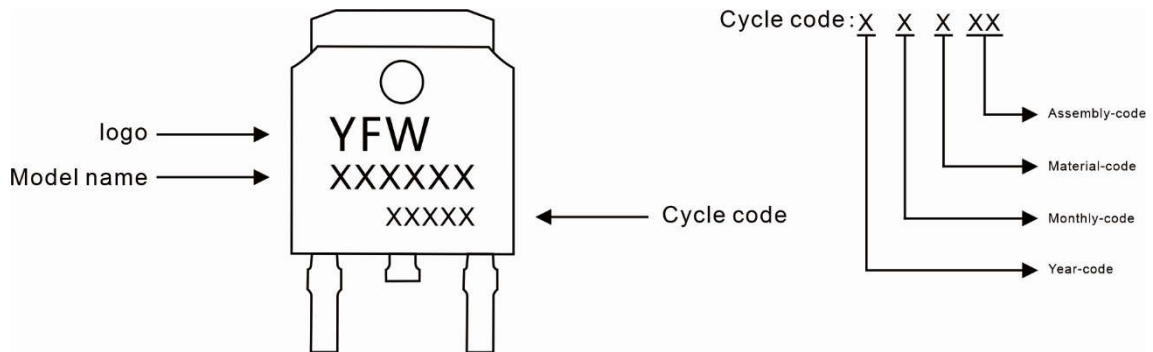

**Ordering information**

Model name	Package	Unit Weight	Base Quantity	Packing Quantity
YFWG160N06AD	TO-252	0.011oz(0.32g)	2500pcs/reel	5000pcs/box 25000pcs/Carton

**Package Dimensions**

**TO-252**

Dim	Millimeter		Inches	
	Min.	Max.	Min.	Max.
A	2.20	2.50	0.087	0.098
A1	0.00	0.12	0.000	0.005
A2	2.20	2.40	0.087	0.094
B	1.20	1.60	0.047	0.063
b	0.50	0.70	0.020	0.028
b1	0.70	0.90	0.028	0.035
c	0.40	0.60	0.016	0.024
c1	0.40	0.60	0.016	0.024
D	6.35	6.65	0.250	0.262
D1	5.20	5.40	0.205	0.213
E	5.40	5.70	0.213	0.224
e	2.20	2.40	0.087	0.094
e1	4.40	4.80	0.173	0.189
L	10.00	11.00	0.393	0.433
L1	2.70	3.10	0.106	0.122
L2	1.40	1.80	0.055	0.071
L3	0.90	1.50	0.035	0.059

## Disclaimer

The information presented in this document is for reference only. Guangdong Youfeng Microelectronics Co.,Ltd. reserves the right to make changes without notice for the specification of the products displayed herein to improve reliability, function or design or otherwise. The product listed herein is designed to be used with ordinary electronic equipment or devices, and not designed to be used with equipment or devices which require high level of reliability and the malfunction of which would directly endanger human life (such as medical instruments, transportation equipment, aerospace machinery, nuclear-reactor controllers, fuel controllers and other safety devices), YFW or anyone on its behalf, assumes no responsibility or liability for any damages resulting from such improper use of sale. This publication supersedes & replaces all information previously supplied. For additional information, please visit our website <https://www.yfwdiode.com>, or consult YFW sales office for further assistance.