

60V N-CHANNEL ENHANCEMENT MODE MOSFET

MAIN CHARACTERISTICS

I_D	6A
V_{DSS}	60V
R_{DS(on)-typ}(@V_{GS}=10V)	< 40mΩ (Type:36 mΩ)

Application

- ◆ LED lamp
- ◆ Load switch
- ◆ Uninterruptible power supply

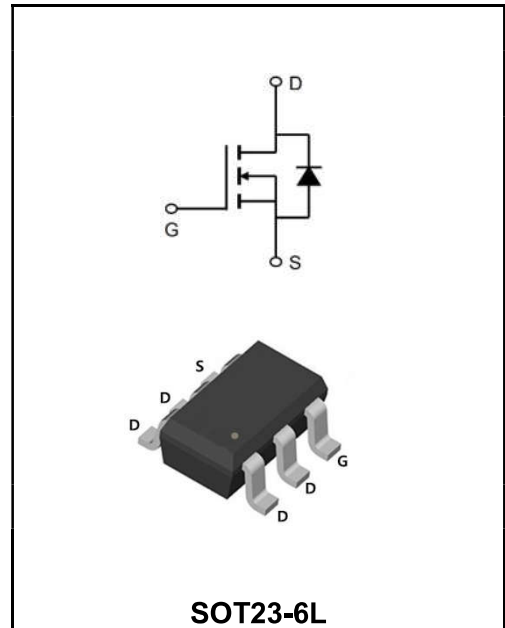

SOT23-6L

Marking Code	
YFW6N06LI	6N06

Maximum Ratings at T_c=25°C unless otherwise specified

Characteristics	Symbols	Value	Units
Drain-Source Voltage	V_{DS}	60	V
Gate - Source Voltage	V_{GS}	±20	V
Continuous Drain Current, V _{GS} @ 10V ¹ @T _C =25°C	I_D	6	A
Continuous Drain Current, V _{GS} @ 10V ¹ @T _C =100°C	I_D	3.5	A
Pulsed Drain Current	I_{DM}	18	A
Single Pulse Avalanche Energy	E_{AS}	22	mJ
Power Dissipation @T _C =25°C	P_D	2	W
Operating and Storage Temperature Range	T_J, T_{STG}	-55 to +175	°C
Thermal Resistance Junction-Ambient ¹	R_{θJA}	125	°C/W
Thermal Resistance Junction-Case ¹	R_{θJC}	4	°C/W

Maximum Ratings at Tc=25°C unless otherwise specified

Characteristics	Test Condition	Symbols	Min	Typ	Max	Units
Drain-Source Breakdown Voltage	$V_{GS}=0V, I_D=250\mu A$	BV_{DSS}	60	65	-	V
BVDSS Temperature Coefficient	Reference to 25°C, $I_D=1mA$	$\Delta BV_{DSS}/\Delta T_J$	-	0.044	-	V/°C
Static Drain-Source On-Resistance ²	$V_{GS}=10V, I_D=15A$	$R_{DS(ON)}$	-	36	40	mΩ
	$V_{GS}=4.5V, I_D=7A$		-	40	48	
Gate -Threshold Voltage	$V_{DS}=V_{GS}, I_D=250\mu A$	$V_{GS(th)}$	1.2	1.6	2.5	V
$V_{GS(th)}$ Temperature Coefficient		$\Delta V_{GS(th)}$	-	-4.8	-	mV/°C
Drain -Source Leakage Current	$V_{DS}=48V, V_{GS}=0V, T_J=25^\circ C$	I_{DSS}	-	-	1	μA
	$V_{DS}=48V, V_{GS}=0V, T_J=55^\circ C$		-	-	5	
Gate-Source Leakage Current	$V_{GS}=\pm 20V, V_{DS}=0V$	I_{GSS}	-	-	±100	nA
Forward Transconductance	$V_{DS}=5V, I_D=15A$	g_{FS}	-	25.3	-	S
Gate Resistance	$V_{DS}=0V, V_{GS}=0V, f=1MHz$	R_g	-	2.5	-	Ω
Total Gate Charge(10V)	$V_{DS}=48V$ $V_{GS}=10V$ $I_D=15A$	Q_g	-	19	-	nC
Gate-Source Charge		Q_{gs}	-	2.5	-	
Gate-Drain Charge		Q_{gd}	-	5	-	
Turn-on delay time	$V_{DD}=30V$ $V_{GS}=10V$ $R_G=3.3\Omega$ $I_D=15A$	$t_{d(on)}$	-	2.8	-	ns
Rise Time		T_r	-	16.6	-	
Turn-Off Delay Time		$t_{d(OFF)}$	-	21.2	-	
Fall Time		t_f	-	5.6	-	
Input Capacitance	$V_{DS}=15V$ $V_{GS}=0V$ $f=1.0MHz$	C_{iss}	-	1027	-	pF
Output Capacitance		C_{oss}	-	65	-	
Reverse Transfer Capacitance		C_{rss}	-	46	-	
Continuous Source Current ^{1,6}	$V_G=V_D=0V, \text{Force Current}$	I_S	-	-	20	A
Pulsed Source Current ^{2,6}		I_{SM}	-	-	40	A
Diode Forward Voltage ²	$V_{GS}=0V, I_S=1A, T_J=25^\circ C$	V_{SD}	-	-	1.2	V
Reverse Recovery Time	$I_F=15A, di/dt=100A/\mu s, T_J=25^\circ C$	t_{rr}	-	12.2	-	ns
Reverse Recovery Charge		Q_{rr}	-	7.3	-	nC

Note :

- 1、 The data tested by surface mounted on a 1 inch2 FR-4 board with 2OZ copper.
- 2、 The data tested by pulsed , pulse width .The EAS data shows Max. rating .
- 3、 The test cond $\cong 300\mu s$ duty cycle $\cong 2\%$, duty cycle ition is $T_J=25^\circ C, V_{DD}=48V, V_G=10V, R_G=25\Omega, L=0.1mH, I_{AS}=13A$
- 4、 The power dissipation is limited by 175°C junction temperature
- 5、 The data is theoretically the same as ID and IDM , in real applications , should be limited by total power dissipation.

Ratings and Characteristic Curves

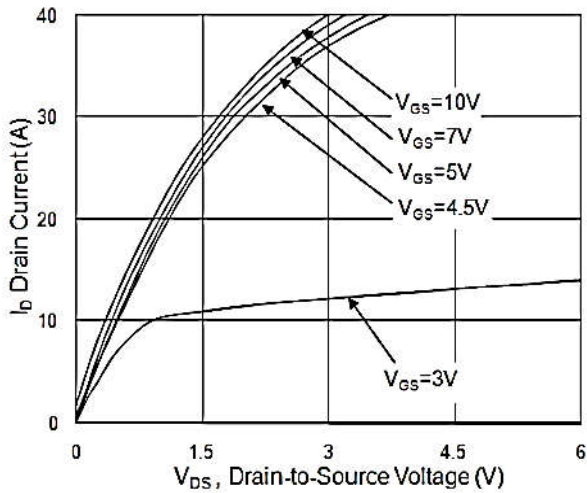

Fig.1 Typical Output Characteristics

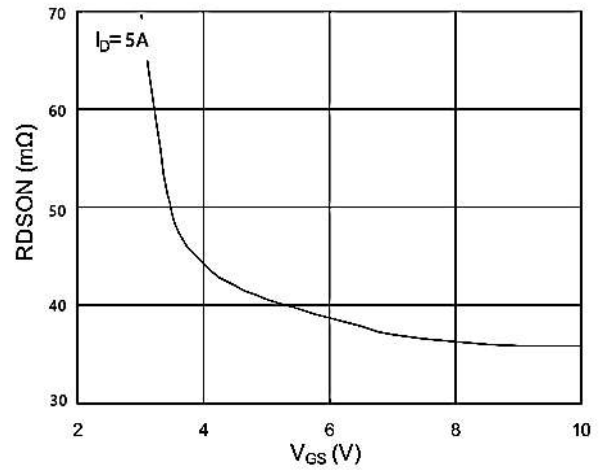

Fig.2 On-Resistance vs. Gate-Source

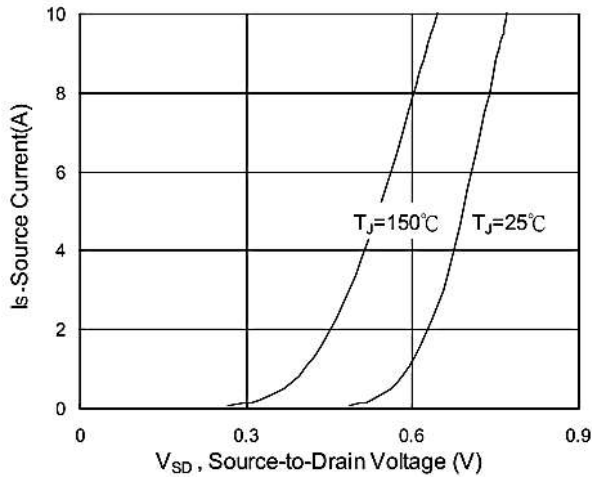

Fig.3 Forward Characteristics Of Reverse

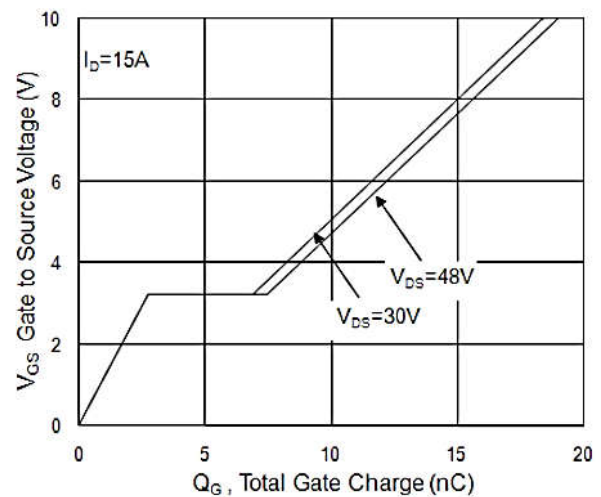

Fig.4 Gate-Charge Characteristics

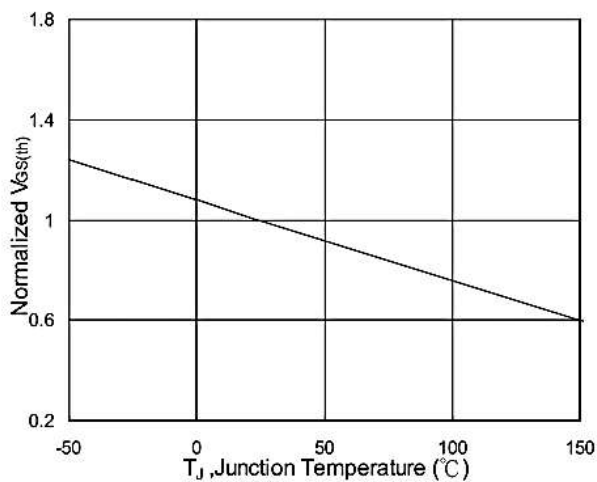

Fig.5 Normalized $V_{GS(th)}$ vs. T_J

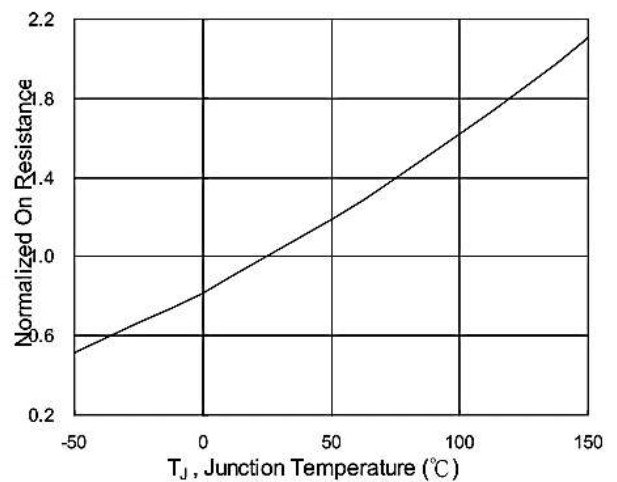

Fig.6 Normalized $R_{DS(on)}$ vs. T_J

Ratings and Characteristic Curves

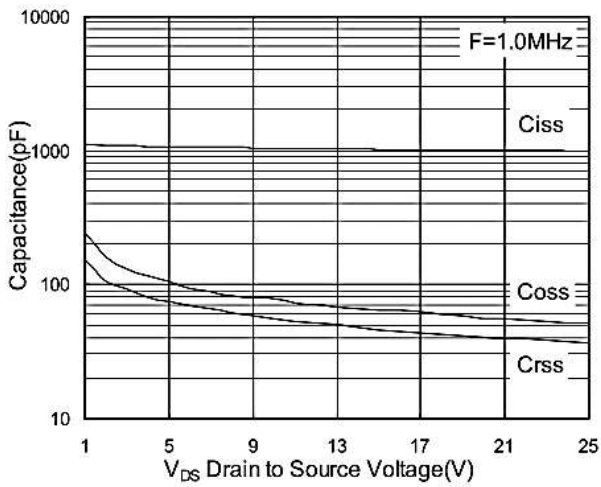

Fig.7 Capacitance

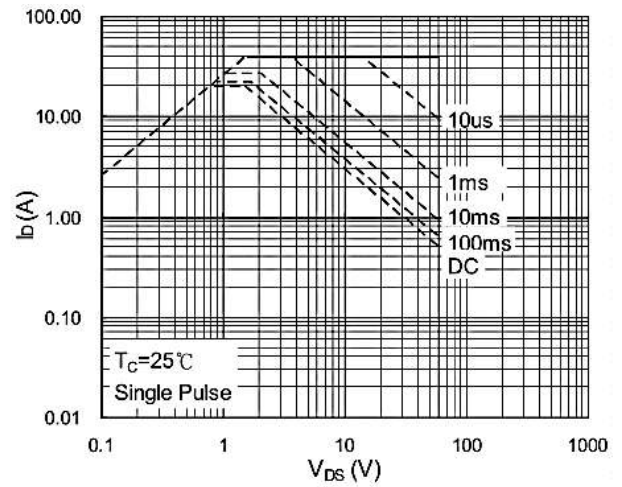

Fig.8 Safe Operating Area

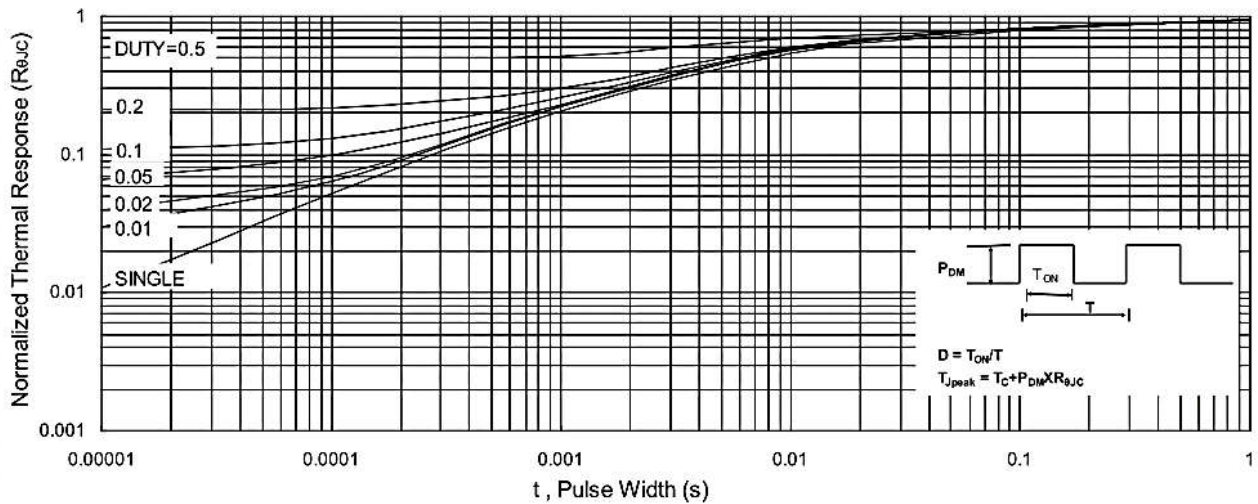

Fig.9 Normalized Maximum Transient Thermal Impedance

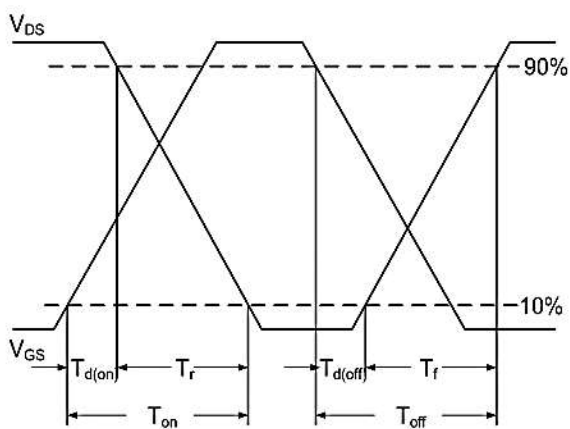

Fig.10 Switching Time Waveform

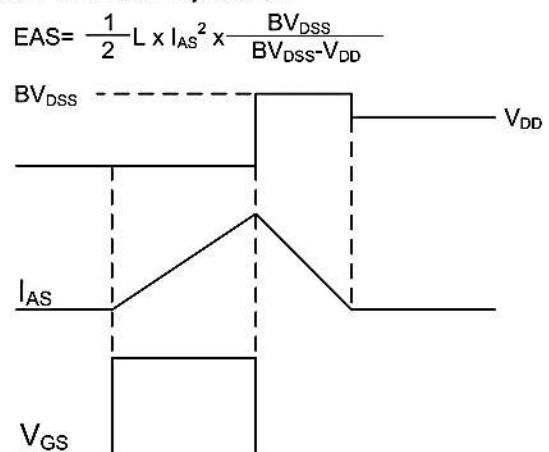

Fig.11 Unclamped Inductive Switching Waveform

Ordering information

Package	Packing Description	Packing Quantity
SOT23-6L	Tape/Reel,7"reel	3000PCS/Reel 120000PCS/Carton

Package Dimensions

SOT23-6L

Dim.	Millimeter(mm)		mil	
	Min.	Max.	Min.	Max.
A	1.05	1.25	41	49
A1	0	0.10	0	3.9
A2	1.05	1.15	41	45
b	0.30	0.50	11.8	19.7
c	0.10	0.20	3.9	7.9
D	2.82	3.02	111	119
E1	1.50	1.70	45	67
E	2.65	2.95	104	116
e	0.950(BSC)		37(BSC)	
e1	1.80	2.00	71	79
L	0.30	0.60	11.8	23.6
θ	0°	8°	0°	8°

The recommended mounting pad size

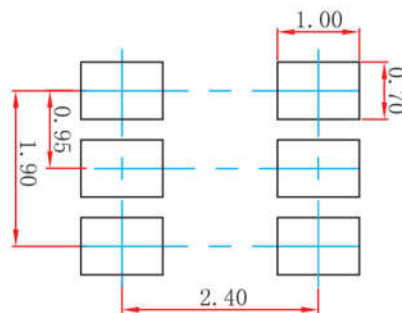

Disclaimer

The information presented in this document is for reference only. Guangdong Youfeng Microelectronics Co.,Ltd. reserves the right to make changes without notice for the specification of the products displayed herein to improve reliability, function or design or otherwise. The product listed herein is designed to be used with ordinary electronic equipment or devices, and not designed to be used with equipment or devices which require high level of reliability and the malfunction of which would directly endanger human life (such as medical instruments, transportation equipment, aerospace machinery, nuclear-reactor controllers, fuel controllers and other safety devices), YFW or anyone on its behalf, assumes no responsibility or liability for any damages resulting from such improper use of sale. This publication supersedes & replaces all information previously supplied. For additional information, please visit our website <https://www.yfwdiode.com>, or consult YFW sales office for further assistance.