

## Transient Voltage Suppressor

### Features

- ◆350 watts peak pulse power ( $t_p = 8/20\mu s$ )
- ◆Unidirectional & Bidirectional Configurations
- ◆Working Voltages: 3.3V, 5V, 8V, 12V, 15V, 24V and 36V
- ◆Low clamping voltages
- ◆Low Leakage Current
- ◆Response Time is Typically  $< 1$  ns
- ◆IEC 61000-4-2 ( ESD )  $\pm 30$ KV contact  $\pm 30$  KV Air
- ◆IEC 61000-4-4 (EFT) 40A (5/50ns)

### Application

- ◆RS-232, RS-422 & RS-485
- ◆Cellular Handsets & Accessories
- ◆Control & Monitoring Systems
- ◆Portable Electronics
- ◆Set-Top Box
- ◆Servers, Notebook, and Desktop PC
- ◆Wireless Bus Protection

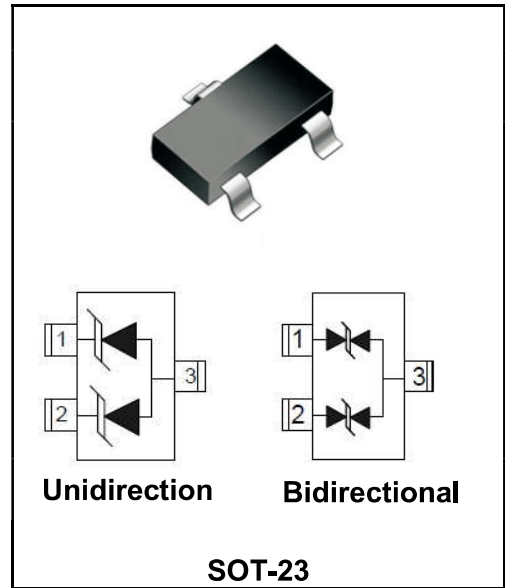

### Limiting Values(TA = 25 °C, unless otherwise specified)

| Symbol           | Parameter                              | Conditions | value       | Unit |
|------------------|--|------------|-------------|------|
| P <sub>PP</sub>  | Peak Pulse Power ( $t_p = 8/20\mu s$ ) | Contact    | 350         | W    |
| TL               | Lead Soldering Temperature             | -          | 260(10sec)  | °C   |
| T <sub>J</sub>   | Operating Temperature                  | -          | -55 to +125 | °C   |
| T <sub>stg</sub> | Storage Temperature                    | -          | -55 to +150 | °C   |

### Electrical Parameters (T=25°C)

| Symbol           | Parameter                                  |
|------------------|--|
| I <sub>PP</sub>  | Maximum Peak Pulse Current                 |
| V <sub>C</sub>   | Clamping Voltage @ I <sub>PP</sub>         |
| V <sub>RWM</sub> | Reverse Stand-Off Voltage                  |
| I <sub>R</sub>   | Reverse Leakage Current @ V <sub>RWM</sub> |
| V <sub>BR</sub>  | Breakdown Voltage @ I <sub>T</sub>         |
| I <sub>T</sub>   | Test Current                               |
| I <sub>F</sub>   | Forward Current                            |
| V <sub>F</sub>   | Forward Voltage @ I <sub>F</sub>           |

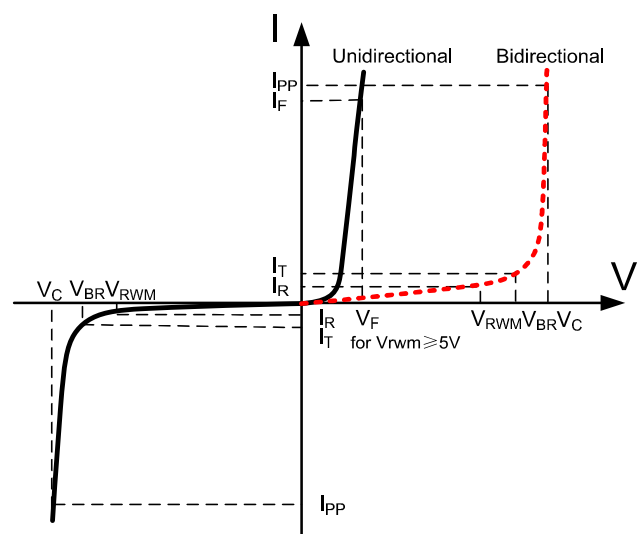

## Electrical Characteristics

| Part Number  | Reverse Stand off Voltage $V_{RWM}$ (Volts) | Minimum Breakdown Voltage $V_{BR@1mA}$ (Volts) | Maximum Peak Pulse Current $I_{pp}$ (Amps) | Maximum Clamping Voltage $V_C@I_{PP}$ (Volts) | Maximum Reverse Leakage $I_R@V_{RWM}$ ( $\mu A$ ) | Typical Capacitance DC=0V $C_J@1\text{ MHz}$ (pF) | Maximum Capacitance DC=0V $C_J@1\text{ MHz}$ (pF) | Marking Code |
|--------------|---|--|--|---|---|---|---|--------------|
| ESD3V3FT233  | 3.3   | 4.0  | 25   | 15  | 1   | 200   | 240   | 3M2          |
| ESD3V3FBT233 | 3.3   | 4.0  | 25   | 15  | 1   | 100   | 120   | 3B2          |
| ESD5VFT233   | 5   | 6.0  | 25   | 16  | 1   | 150   | 180   | 5M2          |
| ESD5VFBT233  | 5   | 6.0  | 25   | 16  | 1   | 75  | 90  | 5B2          |
| ESD8VFT233   | 8   | 9.0  | 20   | 20  | 1   | 70  | 80  | 8M2          |
| ESD8VFBT233  | 8   | 9.0  | 20   | 20  | 1   | 40  | 45  | 8B2          |
| ESD12VFT233  | 12  | 13.3   | 15   | 24  | 1   | 75  | 90  | AM2          |
| ESD12VFBT233 | 12  | 13.3   | 15   | 24  | 1   | 40  | 90  | AB2          |
| ESD15VFT233  | 15  | 16.7   | 12   | 32  | 1   | 45  | 80  | BM2          |
| ESD15VFBT233 | 15  | 16.7   | 12   | 32  | 1   | 25  | 80  | BB2          |
| ESD18VFT233  | 18  | 19.0   | 10   | 34  | 1   | 30  | 70  | EM2          |
| ESD18VFBT233 | 18  | 19.0   | 10   | 34  | 1   | 30  | 70  | EB2          |
| ESD20VFT233  | 20  | 23.5   | 8  | 33  | 1   | 30  | 60  | FM2          |
| ESD20VFBT233 | 20  | 23.5   | 8  | 33  | 1   | 30  | 60  | FB2          |
| ESD24VFT233  | 24  | 26.7   | 7  | 42  | 1   | 25  | 50  | CM2          |
| ESD24VFBT233 | 24  | 26.7   | 7  | 42  | 1   | 25  | 50  | CB2          |
| ESD36VFT233  | 36  | 40   | 6  | 60  | 1   | 15  | 30  | DM2          |
| ESD36VFBT233 | 36  | 40   | 6  | 60  | 1   | 15  | 30  | DB2          |

Typical Characteristics

Peak Pulse Power vs. Pulse Time

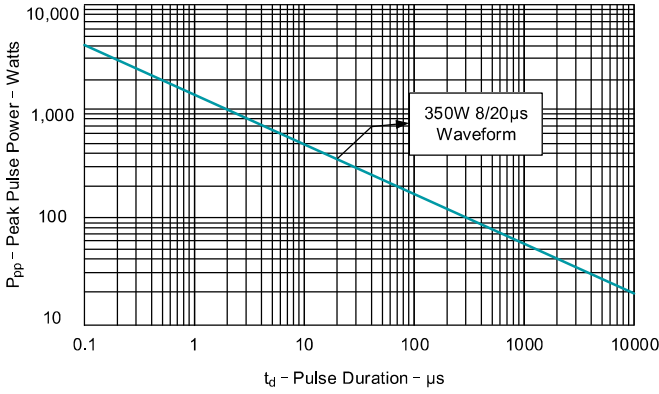

Power Derating Curve

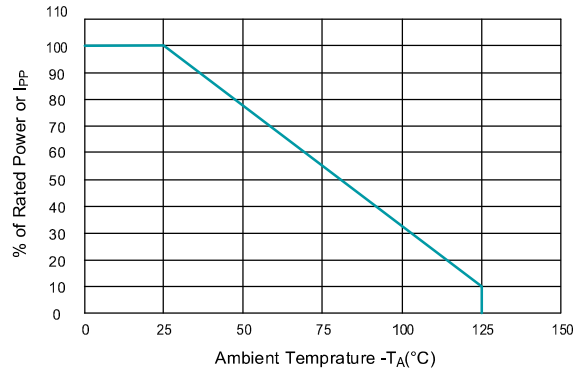

Pulse Waveform

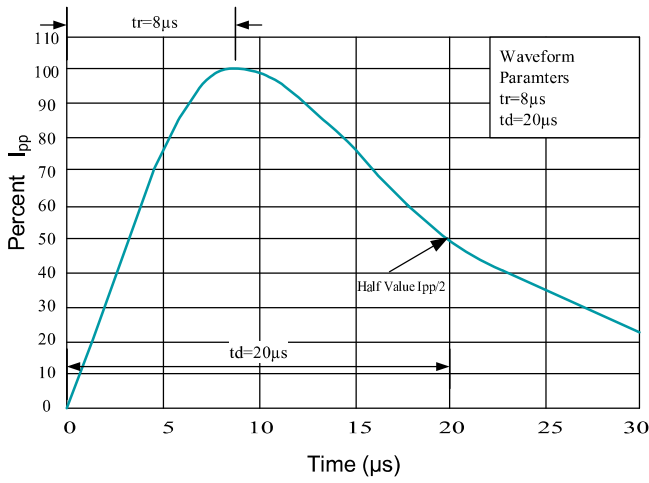

ESD Pulse Waveform (Per IEC 61000-4-2)

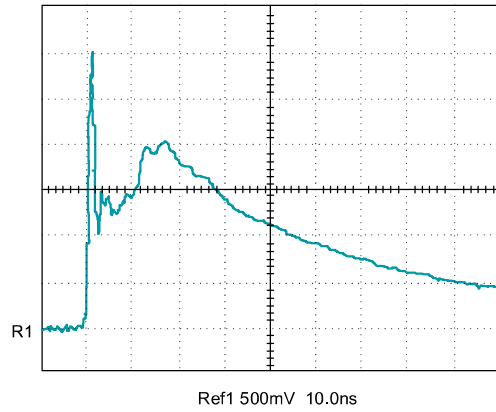

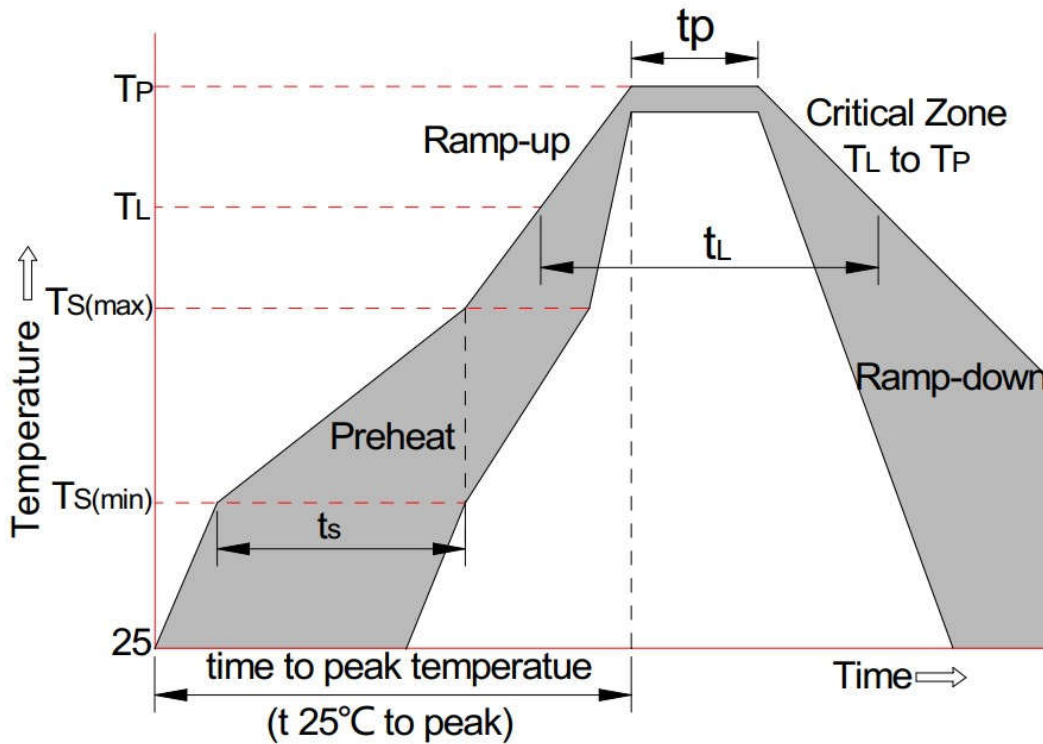

| Reflow Condition                                   |                             | Pb-Free Assembly |
|--|-----------------------------|------------------|
| Pre-heat   | -Temperature Min (Ts(min))  | +150°C           |
|  | -Temperature Max(Ts(max))   | +200°C           |
|  | -Time (Min to Max) (ts)     | 60-190 secs.     |
| Average ramp up rate (Liquid us Temp (TL) to peak) |                             | 5°C/sec. Max     |
| Ts(max) to TL - Ramp-up Rate                       |                             | 5°C/sec. Max     |
| Reflow   | -Temperature(TL)(Liquid us) | +217°C           |
|  | -Temperature(tL)            | 60-150 secs.     |
| Peak Temp (Tp)                                     |                             | +260(+0/-5)°C    |
| Time within 5°C of actual Peak Temp (tp)           |                             | 20-40 secs. Max  |
| Ramp-down Rate                                     |                             | 5°C/sec. Max     |
| Time 25°C to Peak Temp (TP)                        |                             | 8 min. Max       |
| Do not exceed                                      |                             | +280°C           |

Ordering information

| Package | Packing Description | Base Quantity | Packing Quantity              |
|---------|---------------------|---------------|-------------------------------|
| SOT-23  | Tape/Reel,7"reel    | 3000pcs/Reel  | 24000PCS/Box 120000PCS/Carton |

Package Dimensions

SOT-23

| Dim. | Millimeter (mm) |      | mil  |      |
|------|-----------------|------|------|------|
|      | Min.            | Max. | Min. | Max. |
| A    | 0.9             | 1.15 | 35   | 45   |
| A1   | 0.1             |      | 3.9  |      |
| bp   | 0.38            | 0.48 | 15   | 19   |
| C    | 0.09            | 0.15 | 3.54 | 5.9  |
| D    | 2.8             | 3.0  | 110  | 118  |
| E    | 1.2             | 1.4  | 47   | 55   |
| E    | 1.9             |      | 75   |      |
| E1   | 0.95            |      | 37   |      |
| HE   | 2.1             | 2.55 | 83   | 100  |
| Lp   | 0.15            | 0.45 | 5.9  | 18   |
| Q    | 0.45            | 0.55 | 18   | 22   |
| v    | 0.2             |      | 7.9  |      |
| W    | 0.1             |      | 4    |      |

The recommended mounting pad size

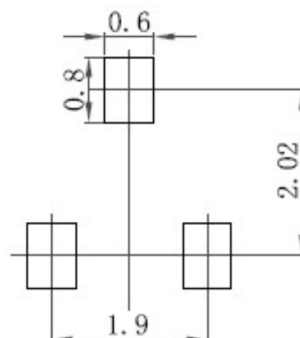

## Disclaimer

The information presented in this document is for reference only. GuangDong Youfeng Microelectronics Co.,Ltd. reserves the right to make changes without notice for the specification of the products displayed herein to improve reliability, function or design or otherwise. The product listed herein is designed to be used with ordinary electronic equipment or devices, and not designed to be used with equipment or devices which require high level of reliability and the malfunction of with would directly endanger human life (such as medical instruments, transportation equipment, aerospace machinery, nuclear-reactor controllers, fuel controllers and other safety devices),YFW or anyone on its behalf, assumes no responsibility or liability for any damages resulting from such improper use of sale. This publication supersedes & replaces all information previously supplied. For additional information, please visit our website <https://www.yfwdiode.com>, or consult YFW sales office for further assistance.